

Horizon

BQ-160

Perfect Binder BQ-160

**Professional quality books with a simple process.
Up to 40 mm / 1.6" thick books can be bound.**



A Perfect Finishing Solution for On Demand Production!

Simple touchscreen operation and an efficient binding procedure achieves production rates up to 180 cycles per hour.



Simple Operation

Quick and Easy Production Steps.

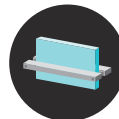

Clamping

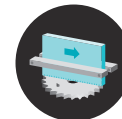

Notching



Glue application



Cover application

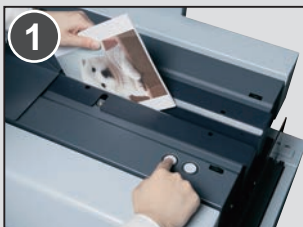

1 Insert the book block and press the start button.

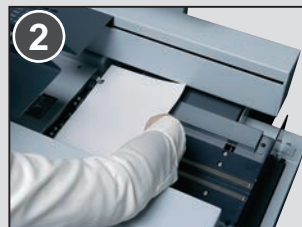

2 Place the cover and press the start button again.



3 Glue is applied on the spine of the book.



4 A cover is applied and book binding is completed.

1 Color Touchscreen

A graphical icon-based color touchscreen is provided for easy set-up and operator navigation.



Ecology functions:

Power saving mode (stand-by mode): If the system is not used for a predetermined period, the glue tank heater will automatically adjust to a lower temperature.

Auto shut down mode: If the system is not used for a predetermined period of time, the system automatically shuts down.

2 Clamper Section

The clamp opens and closes with the simple press of a button for operator convenience.

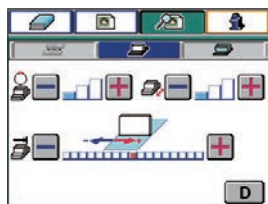

Clamper setting

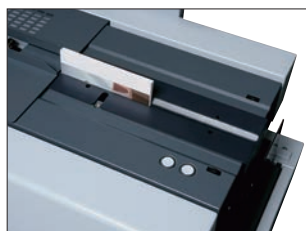

3 Notching Section

The double-pass notching function produces strong book binds. Notching can be easily set ON or OFF from the touchscreen.



Notching setting



4 Glue Tank Section

Uniquely designed glue tank ensures superior glue application to the book spine for quality binding.



5 Nipping Section

Strong nipper mechanism ensures quality book binds. Nipping pressure, nipping height and angle can be adjusted from the touch screen.

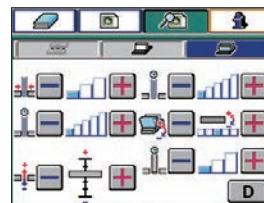

Nipper setting screen



6 Cover Section

Perfect binding, tape binding and padding can be performed. Tape width can be adjusted automatically by selecting desired width from the touchscreen.



Perfect binding setting

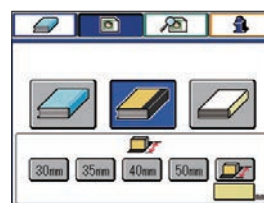
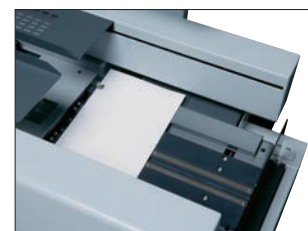

Tape binding setting



7 Creaser (CRB-160): Option

Optional CRB-160 impact creaser can be on-line to prepare creased (up to 8 line) cover.

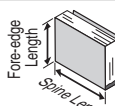
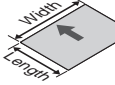

CRB-160

BQ-160 Major Specifications	
Binding Type	Cover Binding, Tape Binding, Pad Binding
Book Block Size	 Spine Length x Fore-edge Length Max. 350 x 300 mm / 13.7" x 11.8" Min. 70 x 128 mm / 2.8" x 5.1"
Book Block Thickness	1 to 40 mm / 0.04" to 1.6"
Cover Size	 Length x Width Max. 350 x 640 mm / 13.7" x 25.1" Min. 70 x 256 mm / 2.8" x 10.1"
Cover Weight Range	82 to 302 gsm / 22 to 80 lb
Glue Temperature	120 to 200 °C / 248 to 392 °F - 180 °C or 356 °F for HM-110 glue - 140 °C or 284 °F for optional HM-302 low temperature glue
Cycle Speed	Max. 180 cycles per hour (Cover Binding) Max. 120 cycles per hour (Pad binding)
Voltage/Frequency	Single Phase 115 to 120 V, 50 / 60 Hz Single Phase 220 to 240 V, 50 / 60 Hz
Rated Current	Single Phase 115 to 120 V, 50 / 60 Hz, 7.7 A Single Phase 220 to 240 V, 50 / 60 Hz, 3.5 A
Machine Dimensions	W1,370 x D540 x H1,331 mm / W54.0" x D21.3" x H52.5
Machine Weight	204 kg / 449.8 lb

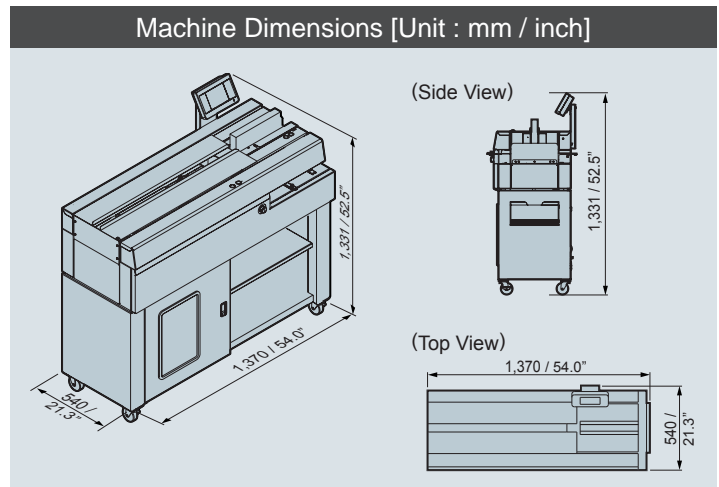

*The machine design and specifications are subject to change without any notice.

Wide ranges of perfect binders are available

BQ-P60 : Tabletop Perfect Binder



BQ-270V : Single-Clamp Binder



BQ-470 : 4-Clamp Binder



Major Specifications

	BQ-P60	BQ-160	BQ-270V	BQ-470
Binding Type	Cover Binding, Tape Binding, Pad Binding	Cover Binding, Tape Binding, Pad Binding	Binding with milling, Binding without milling, and Pad binding	Binding with milling, Binding without milling and Pad binding
Number of Carriage Clamps	1	1	1	4
Book Block Size (Spine Length x Fore-edge Length)	Max. 315 x 210 mm / 12.4" x 8.2" Min. 210 x 148 mm / 8.3" x 5.9"	Max. 350 x 300 mm / 13.7" x 11.8" Min. 70 x 128 mm / 2.8" x 5.1"	Max. 320 x 320 mm / 12.59" x 12.59" Min. 135 x 105 mm / 5.32" x 4.14"	Max. 320 x 320 mm / 12.59" x 12.59" Min. 145 x 105 mm / 5.71" x 4.14"
Book Block Thickness	Max. 25 mm / 0.9"	1 to 40 mm / 0.04" to 1.6"	1 to 50 mm / 0.04" to 2.00"	1 to 65 mm / 0.040" to 2.560"
Cycle Speed	Max. 180 cycles per hour	Max. 180 cycles per hour (Cover Binding) Max. 120 cycles per hour (Pad binding)	Max. 500 cycles per hour	Max. 1,350 cycles per hour (EVA) Max. 1,000 cycles per hour (PUR)