

**Horizon**



# SPF-200 series

Bookletmaker SPF-200A / 200L + FC-200A / 200L

## In-line booklet-making system



**Horizon**  
Stitch and Folder SPF-200L



The SPF-200 series bookletmaking system features high productivity, fully automated changeover and user-friendly operation.



**Advanced Automation**

All necessary settings for a wide variety of booklet formats, ranging from CD to A4 landscape (A4 landscape is available only with SPF-200L) can be performed automatically through the touchscreen display. Even the fold roller gap adjustment is automated. The quick fully-automatic changeover is suited for efficient small lot production and leads to a reduction of test sheets.

**Color Touchscreen for Easy Operation**

The 10.4 inch large color touchscreen features an intuitive, icon-based display for easy operation and quick troubleshooting.

**Supporting both Digital and Offset Print**

The SPF-200 series booklet-making system provides flexible system configurations. The VAC-1000 can be connected for conventional offset print production and the HOF-400 offline feeder can be connected to handle digital output.

**Cost Savings**

The SPF-200 series booklet-making system processes the pre-cut 4-page sheets instead of folded signatures to eliminate the folding process.

**High Speed Production**

Maximum production speed is 4,500 books per hour with A5 booklets.

**Non-stop Operation**

A reject function allows non-stop operation. Errored booklets are rejected into the built-in reject tray so only good booklets are delivered to the conveyor for non-stop operation and accurate bookletmaking.

**Quality Control**

The wire feeding sensor and jog sensor are equipped to maximize productivity and efficiency. Optional mis-stitch detector and thickness detector are available for even higher quality control.

**A Wide Range of Optional Units**

A wide range of optional units such as a hole punch unit, paper insertion knife unit and preset kicker are available to meet varying customer needs.

**JDF Workflow**

The system can be further enhanced with Horizon's pXnet bindery control system which integrates JDF workflow from upstream devices.

**A4 Landscape booklet production**

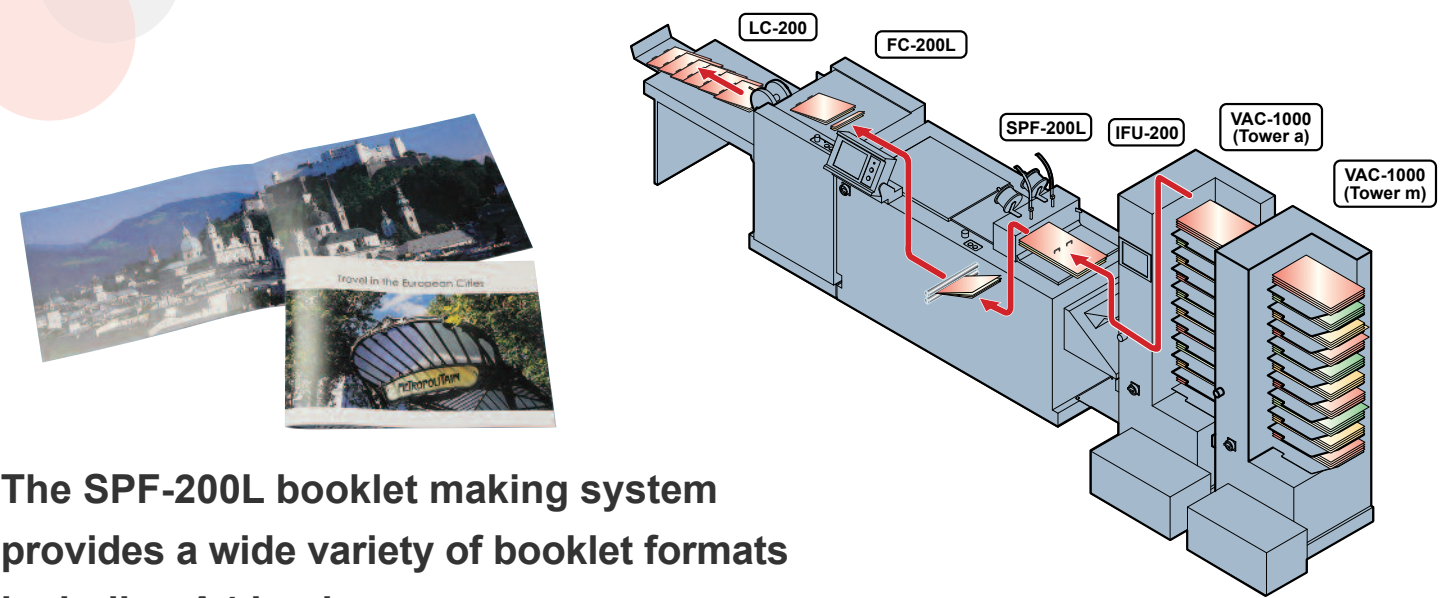

The SPF-200L booklet making system provides a wide variety of booklet formats including A4 landscape.

This expanded capability provides a wider range of formats, to support the demanding market needs.



LG-1000: Landscape Guide  
LG-1000 enables sheet lengths up to 610 mm / 24" to be loaded for A4 landscape booklet production.







## 1 Color Touchscreen



- 10.4 inch color touchscreen is intuitive and icon-based for user-friendly operation.
- With just one touch, the finishing format can be selected.
- 200 job settings can be entered and stored. The operator can name stored jobs alpha-numerically, for quick easy search and retrieval.
- The collating system and the fore-edge trimming can be controlled from the control panel.
- Fine adjustments can be performed on-the-fly while running for high quality finishing.

## 2 Hand Marrying: IFU-200 (Option)

- The IFU-200 allows hand feeding of previously collated sets, heavy cover material or difficult stocks in three modes.

### Hand marrying mode 1:

Insert one booklet.

### Hand marrying mode 2:

Merge a hand fed set on top of a set from the collator.

### Hand marrying mode 3:

Merge a set from the collator on top of a hand fed set.

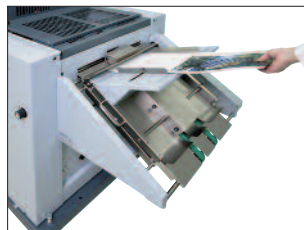

## 3 Jogging

- Jog count and stroke can be set to handle a wide variety of sheets.



## 4 Stitching

- The wire feeding sensor alerts when the wire spool is nearly empty or jamming, and stops the system to eliminate non-stitched booklets.
- Up to 48 sheets of normal paper (64 gsm / 50lb. offset) can be stitched or up to 24 sheets of normal paper (64 gsm / 50lb. offset) can be stitched and folded.
- The stitching position and distance are automatically set up for the input size.

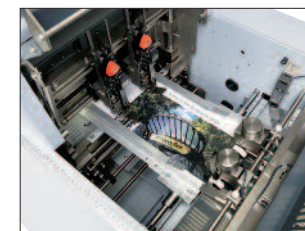

## 5 Folding

- Folding roller and press roller gaps are automatically adjusted according to the booklet thickness.
- The jog sensor detects jog faults and rejects any errored booklets to the reject tray.
- Sheets are firmly registered with tail edge and top-bottom guides to provide accurate folds.

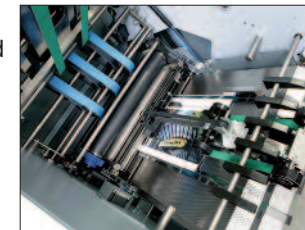

## 6 Fore-edge Trimming

- The servo-motor is employed for knife driving to provide high speed and sharp fore-edge trimming.
- The top-bottom transport belt insures smooth booklet transportation and delivery.
- Trimmings are blown down into the external trim box by air so that no chips are left in the trimming area.
- Durable casting structure for quality trimming.

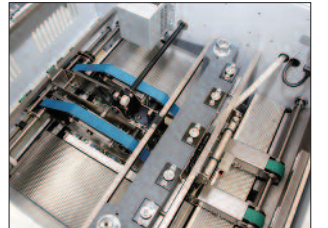

## 7 Conveyor

- Either the SC-200 Short Conveyor or the LC-200 Long Conveyor is available.
- Conveyor belt running time and batch counter can be controlled from the touchscreen.
- Booklets on the conveyor can be easily delivered by pressing the eject button.

### Short Conveyor: SC-200

- Finished booklets are neatly delivered to the exit conveyor.

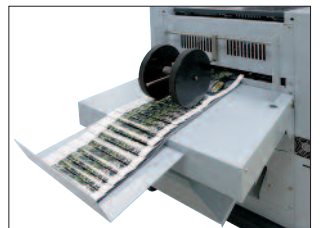

### Long Conveyor: LC-200

- The LC-200 is 54 cm / 21.2" longer than the SC-200 Short Conveyor. A large number of booklets can be neatly delivered.

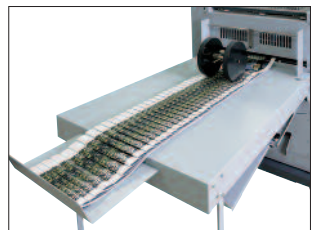

## 8 Faulty Set Rejection

- Errored sets are rejected to the reject tray so that only correct booklets are delivered to the conveyor.



Options

### HOF-400

#### High Speed Off-line Feeder

- The HOF-400 can feed at a speed of 25,000 sheets per hour (A3 / 11" x 17") and 35,000 sheets per hour (A4 SEF/8.5" x 11"). This high speed feeding is capable of handling the output of multiple printers.
- Feature rich newly designed 7" color touch screen display for easy and intuitive operation.
- The HOF-400 is compatible with a wide variety of system configurations such as sheet feeding, cover feeding, accumulating, bleed trimming and center creasing depending on your needs.
- The HOF-400 is equipped with a high quality feed detection system for reliable processing. If a mis-feeding occurs in the HOF-400, the system stops before stitching.

**Ultrasonic Sensor:** Miss-feed, double-feed or jam detection  
**Mark sensor:** Page order detection (top and last sheet)



### HP-200A

#### Hole Punch Unit

- The HP-200A can perform efficient hole-punching bookletmaking in-line with the SPF-200A.
- Necessary settings and operation can be performed automatically by inputting the sheet size in the color touchscreen on the SPF-200A. Changeover for 2 holes and 4 holes is easy for user-friendly operation.
- The top-bottom transport belt insures stable booklet transportation. Blower air at fore-edge jog section is equipped as a standard for more accurate and stable production.
- High speed hole punching can be performed without effect on \*the production speed of the SPF-200A. Hole punch, press and through modes can be selected for efficient in-line bookletmaking production.

\*Production speed changes depending on the binding mode, booklet thickness and sheet condition.



### ST-40

#### Bypass Stacker

- Connected between the collating and bookletmaking systems, the ST-40 serves as a high-capacity offset or straight stacking device.
- Errored sets are delivered to the built-in reject tray for non-stop operation.
- A continuously cycling tail jog keeps all sheets well positioned for superior stack quality.



Bypass Stacker : ST-40

### TBC-200L

#### Top and Bottom Trimmer

- TBC-200L can be connected with the SPF-200/FC-200 series bookletmaking system. A stand alone model is also available to connect to your existing bookletmaker.
- Up to 305 mm / 12" spine-to-face can be finished for A4 landscape booklet production.
- Set-up and operation can be controlled from the SPF-200 series touchscreen. An individual touch screen is equipped on the stand alone model.



Easy access to the knife section for setup and maintenance. Operator safety is ensured with the interlocked cover.

The whole transport section can be opened for easy booklet access and handling.

Booklets are firmly transported and jogged with a uniquely designed system that ensures accurate trim quality.

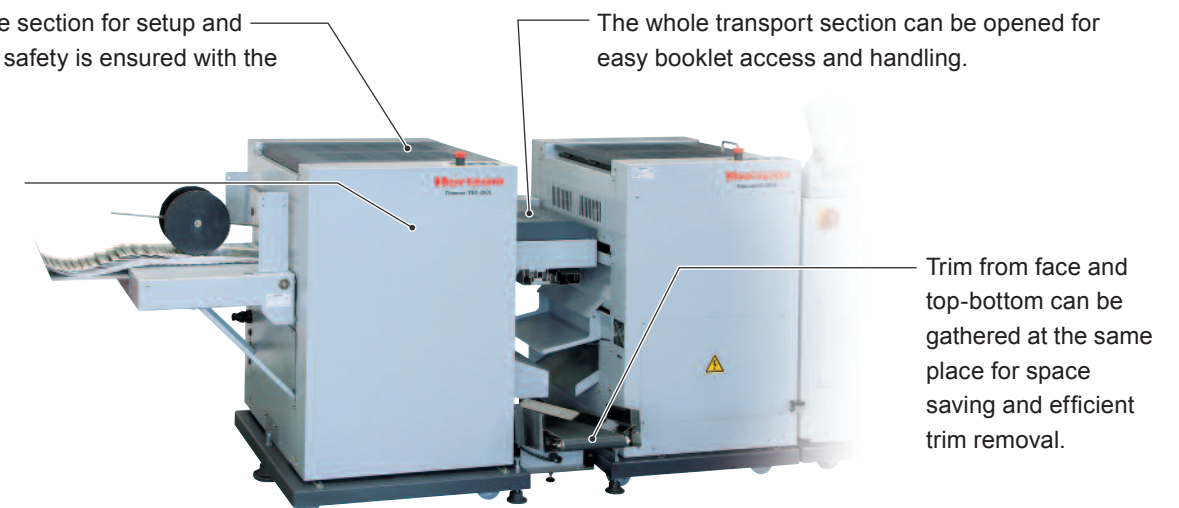



Available Combination of Models and Dimensions (Unit : mm / inch)

The available range of sheet size and sheet weight can be limited depending on the connected models. The production speed is affected by the combination of the models.

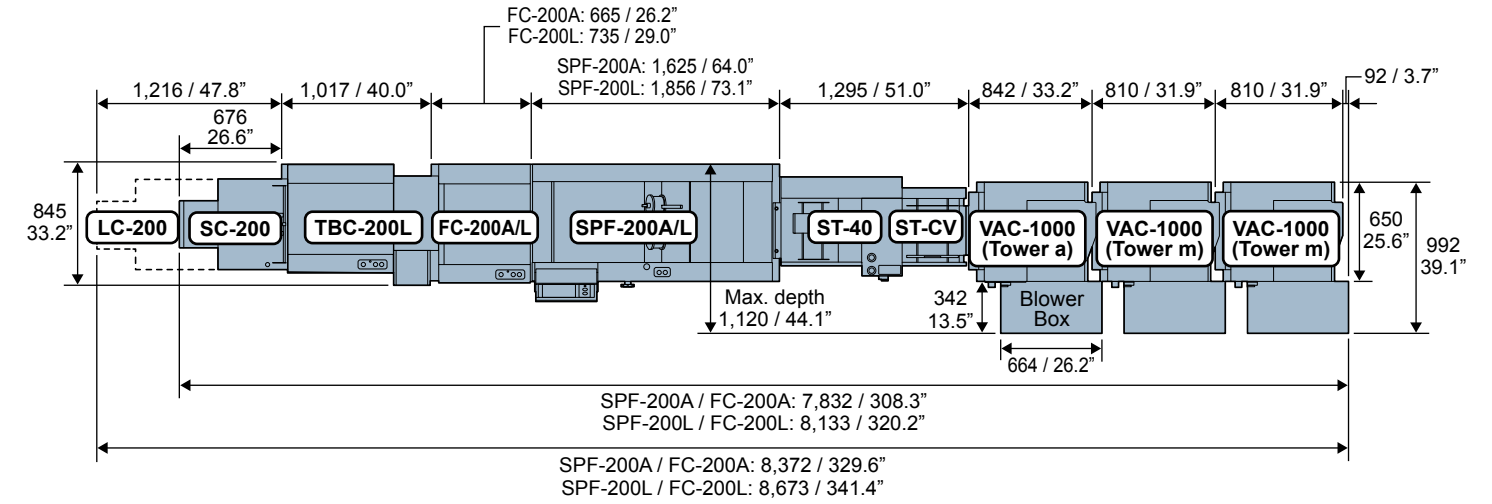
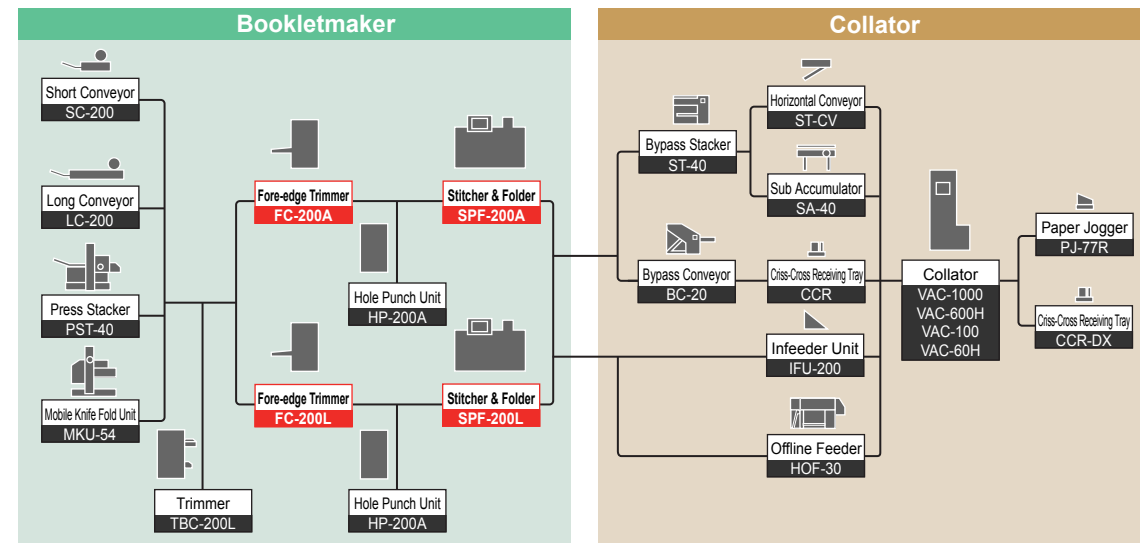

Combination of Models for Offset Print

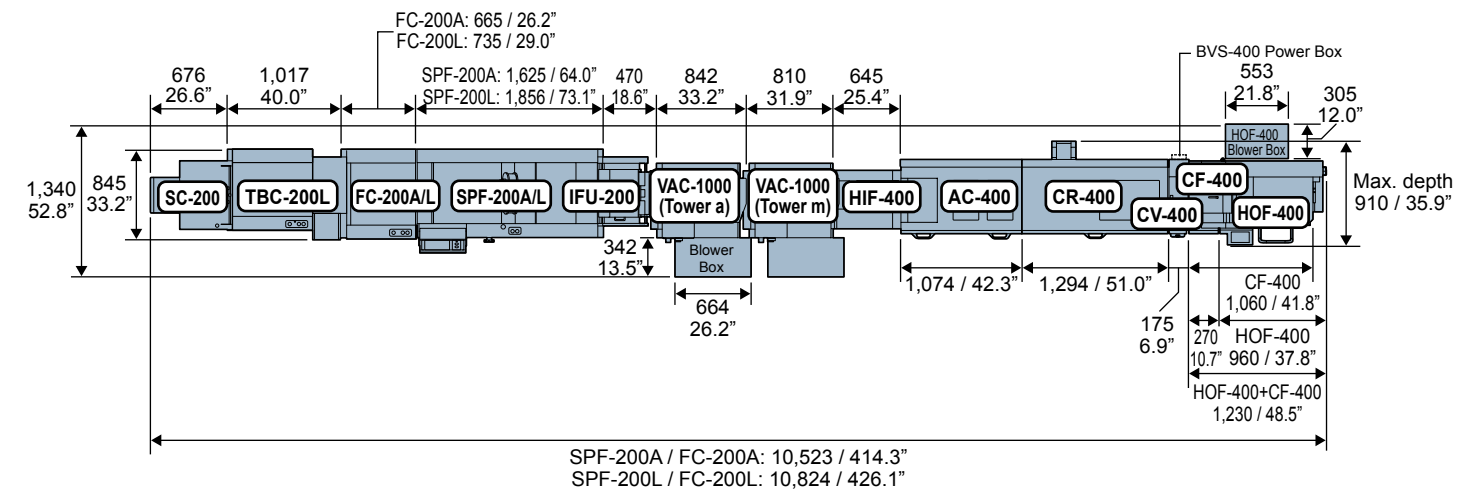
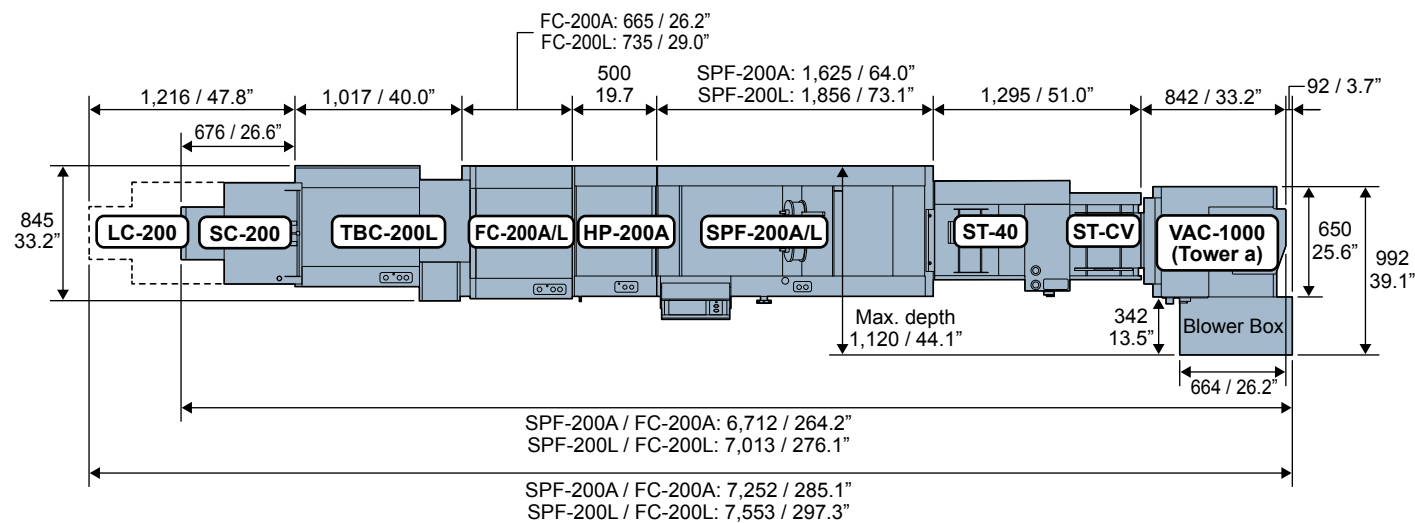
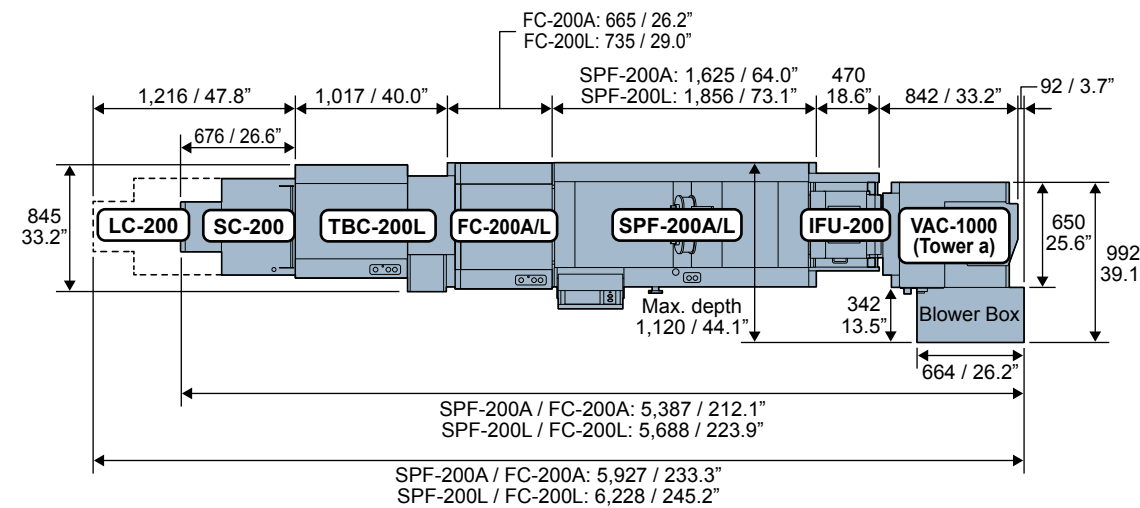
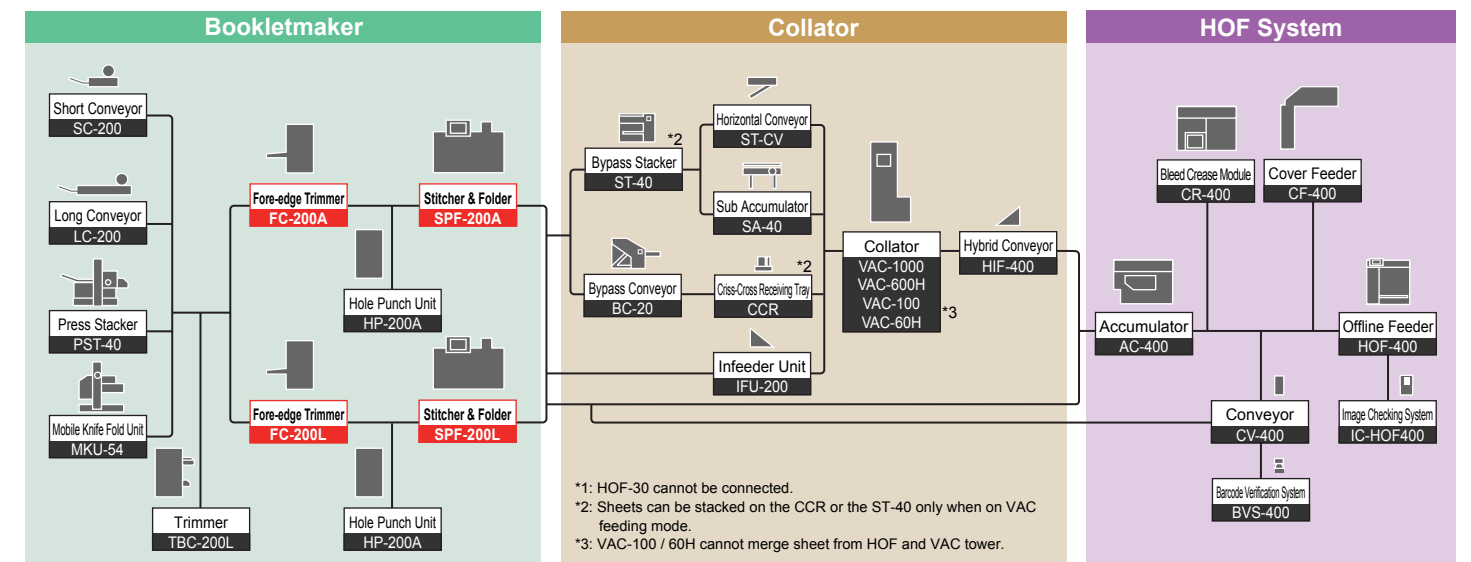

Combination of Models for Digital Print

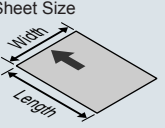
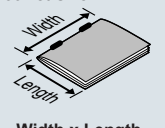

Specifications

Model	SPF-200A	SPF-200L
Functions	Saddle Stitch, Top Stitch and Fold, Fold only (Option SSK-200A/200L: Top/Side Stitch, Pass Through, Corner Stitch [Front/Rear], Corner Stitch and Fold)	
 <p>Sheet Size</p> <p>Width x Length</p> <p>The range of sheet sizes available can be limited when the sheets are fed from the connected machine.</p>	Saddle Stitch, Fold only, Pass Through	
	Max. 356 x 508 mm / 14.000" x 20.000" Min. 120 x 180 mm / 4.725" x 7.090"	Max. 356 x 610 mm / 14.000" x 24.000" Min. 120 x 180 mm / 4.725" x 7.090"
	Top/Side Stitch	
	Max. 356 x 432 mm / 14.000" x 17.000" Min. 180 x 138 mm / 7.090" x 5.435"	
	Top Stitch and Fold	
Max. 356 x 432 mm / 14.000" x 17.000" Min. 180 x 180 mm / 7.090" x 7.090"		
Corner Stitch, Corner Stitch and Fold		
Max. 326 x 364 mm / 12.820" x 14.330" Min. 210 x 210 mm / 8.270" x 8.270"		
Sheet Weight Range	Normal Paper: 64 to 157 gsm Art Coated Paper: 84.9 to 157 gsm	
 <p>Booklet Size</p> <p>Width x Length</p>	Saddle Stitch, Fold only	
	Max. 356 x 254 mm / 14.000" x 10.000" Min. 120 x 90 mm / 4.725" x 3.545"	Max. 356 x 305 mm / 14.000" x 12.000" Min. 120 x 90 mm / 4.725" x 3.545"
	Top Stitch and Fold	
	Max. 356 x 216 mm / 14.000" x 8.500" Min. 180 x 90 mm / 7.090" x 3.545"	
	Corner Stitch and Fold	
Max. 326 x 182 mm / 12.820" x 7.165" Min. 210 x 105 mm / 8.270" x 4.135"		
Stitch Thickness	Top/Side Stitch, Corner Stitch and Fold Max. 4 mm / 0.155" (About 48 sheets of normal paper 64 gsm)	
Fold Thickness	Saddle Stitch Max. 2 mm / 0.075" (About 24 sheets of normal paper 64 gsm) (About 16 sheets of normal paper 81.4 gsm)	
Stitch Distance	73 to 290 mm / 2.875" x 11.400" Adjustable When saddle stitching, the stitch distance may be limited by the fold knife.	
Corner Stitching Position	 <p>3 to 15 mm / 0.120" to 0.590" Adjustable</p>	
Stitching Wire	Standard: 0.5 mm (No.26) Option: 0.45 mm (No.27) Wire of 0.4 to 0.6 mm diameter can be installed on the standard stitcher.	
Production Speed	Max. 4,000 booklets per hour (A4-Finish, Portrait) Max. 4,500 booklets per hour (A5-Finish, Portrait)	Max. 4,000 booklets per hour (A4-Finish, Portrait) Max. 3,500 booklets per hour (A4-Finish, Landscape)
Voltage/Frequency	Single Phase 200 to 220 V, 50 / 60 Hz Single Phase 230 to 240 V, 50 / 60 Hz	
Machine Dimensions	W1,625 x D810 x H1,250 mm / W64.0" x D31.9" x 49.3"	W1,856 x D810 x H1,250 mm / W73.1" x D31.9" x 49.3"

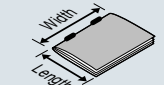
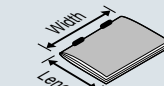
Model	FC-200A	FC-200L
 <p>Untrimmed Booklet Size</p> <p>Width x Length</p>	Max. 356 x 254 mm / 14.000" x 10.000" Min. 120 x 90 mm / 4.725" x 3.545"	Max. 356 x 305 mm / 14.000" x 12.000" Min. 120 x 90 mm / 4.725" x 3.545"
	Finished Booklet Size	
 <p>Finished Booklet Size</p> <p>Width x Length</p>	Max. 356 x 250 mm / 14.000" x 9.840" Min. 120 x 85 mm / 4.725" x 3.350"	Max. 356 x 305 mm / 14.000" x 12.000" Min. 120 x 85 mm / 4.725" x 3.350"
	Trim Width	
Max. 20 mm / 0.785" Min. 2 mm / 0.075"		
Trim Thickness		
Max. 4 mm / 0.155"		
Production Speed	Max. 4,000 booklets per hour (A4-Finish, Portrait) Max. 4,500 booklets per hour (A5-Finish, Portrait)	Max. 4,000 booklets per hour (A4-Finish, Portrait) Max. 3,500 booklets per hour (A4-Finish, Landscape)
Voltage/Frequency	Single Phase 200 to 240 V, 50 / 60 Hz	
Machine Dimensions	W665 x D810 x H1,070 mm / W26.2" x D31.9" x H42.2"	W735 x D810 x H1,070 mm / W29.0" x D31.9" x H42.2"

Options

We have a large choice of optional accessories other than those listed below. Contact your local dealer about required options for meeting your needs.

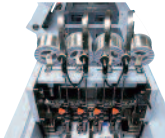
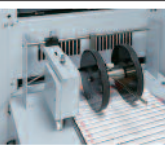
Four Stitching Unit: FST-200	Additional stitcher heads can be mounted for up to 4 stitches per booklet. Optional stitcher heads (#27 – thickness 0.45 mm) are available.	
Loop Stitch Kit (Part No. 9964401)	An optional loop stitch kit can be fitted to the standard stitcher heads to meet a variety of customer applications. Loop stitch kit is required for each stitcher head.	
Side/Corner Stitch Unit: SSK-200A/SSK-200L	The SSK-200A/SSK-200L enables the SPF-200A/SPF-200L to perform Side/Corner stitching. Side/Corner stitched set can be delivered to the same delivery conveyor used for booklets without any change.	
Booklet Thickness Detector: TD-200	The TD-200 checks the thickness of each booklet. An errored book is rejected to the reject tray for non-stop operation.	
Preset Kicker: PK-30	According to a preset number input on the touchscreen, one booklet is skewed to easily identify and separate the end of a series.	
Chip Extractor: TB-200	Powerfully blows out cutting waste from the fore-edge trimmer.	
Paper Insertion Knife Unit: PN-200	The PN-200 inserts a single sheet into the center spread of a booklet. For example, an A4 size single sheet can be inserted into the A3 size booklet.	
Mis-Stitch Detector: SDS-200	The SDS-200 checks the stitch on each booklet for higher quality control. A mis-stitched booklet is rejected to the reject tray for non-stop operation.	

HOF-400 Major Specifications

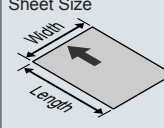
 <p>Sheet Size</p> <p>Width x Length</p>	Max. 356 x 610 mm / 14.0" x 24.0" Min. 203 x 203 mm / 8.0" x 8.0"
	Sheet Weight Range
Normal Paper: 52 to 157 gsm Coated Paper: 73 to 157 gsm *When you use thin sheets, you need to decrease the speed depending on the sheet size. *The machine can feed thick sheets (157 through 209 gsm), but the feed speed will decrease.	
Production Speed	Max. 25,000 sheets per hour (A3) 35,000 sheets per hour (A4 SEF) 45,000 sheets per hour (A4 LEF) (When the sheets are processed one by one.)  4,000 booklets per hour (Without Creasing, 16-page, A4 size booklet) 3,200 booklets per hour (With Creasing, 16-page, A4 size booklet) 5,000 booklets per hour (Without Creasing, 16-page, A5 size booklet) 4,000 booklets per hour (With Creasing, 16-page, A5 size booklet) The production speed is limited depending on the stitcher.
Sheet Pile Height on Feed Tray	Max. 620 mm / 24.4"
Voltage/Frequency	3-phase 200 to 220 V, 50 Hz / 60 Hz 3-phase 380 / 400 / 415 V, 50 / 60 Hz
Machine Dimensions	HOF-400 : W960 x D740* x H936 mm / 37.8" x 29.2" x 36.9" (*When including the blower box : 1,050 mm / 41.4") Blower Box : W553 x D305 x H350 mm / 21.8" x 12.0" x 13.8"

HP-200A Major Specifications

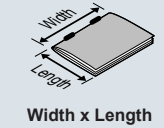
 <p>Sheet/Booklet Size</p> <p>Width x Length</p>	Punch/Press	Max. 356 x 254 mm / 14.000" x 10.000" (When inserting a paper, 356 x 235 mm / 14.000" x 9.250") Min. 210 x 148 mm / 8.270" x 5.830"
	Through	Max. 356 x 508 mm / 14.000" x 20.000" Min. 120 x 90 mm / 4.725" x 3.545" Maximum Thickness of Sheet Block 4mm or 0.157"(depending on the sheet weight)
Sheet Weight Range	Normal Paper : 64 to 157 gsm, Art Coated Paper : 85 to 157 gsm	
Punch Thickness	Max. 3.2 mm / 0.12" (Up to 40 sheets, 20 sheets stitched and folded, of 64 gsm)	
Number of Holes	4 holes	
Punch Hole Pitch	80 mm	
Punch Hole Position	Dimension from the booklet spine to center of hole can be adjusted from 9 through 14 mm with panel setting.	
Punch Hole Diameter	6 mm	
Production Speed	Saddle Stitch	Max. 4,300 booklets per hour (A5 booklet, booklet thickness 2.5 mm or less) Max. 4,000 booklets per hour (A4 booklet, booklet thickness 2.5 mm or less)
	Fold Only	Max. 4,000 booklets per hour (A5 booklet, booklet thickness 2.5 mm or less) Max. 3,700 booklets per hour (A4 booklet, booklet thickness 2.5 mm or less)
Voltage/Frequency	Single Phase 220 to 240 V, 50 / 60 Hz	
Machine Dimensions	W500 x D770 x H1,035 mm / W19.7" x D30.4" x H40.8"	

ST-40 Major Specifications

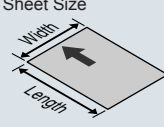
 <p>Sheet Size</p> <p>Width x Length</p>	Max. 350 x 500 mm / 13.8" x 19.7" Min. 182 x 128 mm / 7.2" x 5.0"
	Sheet Weight Range
52 to 208 gsm	
Production Speed	8,000 sets per hour (A4 or 8.5" x 11" / 10 sheets / straight stacked) 5,000 sets per hour (A4 or 8.5" x 11" / 10 sheets / off-set stacked)
Stack Capacity	360 mm / 14.1"
Max. Transport Thickness	6 mm / 0.24"
Voltage/Frequency	Single Phase 200 / 220 V, 50 / 60 Hz Single Phase 230 V, 50 Hz
Machine Dimensions	W1,353 x D652 x H1,027 mm / W53.3" x D25.7" x H40.5" (including feed error tray)

TBC-200L Specifications

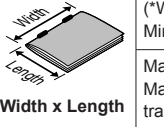
 <p>Untrimmed Booklet Size</p> <p>Width x Length</p>	Max. 356 x 305* mm / 14" x 12" (*When connecting with SPF-200L) Min. 120 x 85 mm / 4.725" x 3.347"
	Finished Booklet Size
Max. 352 x 305 mm / 13.84" x 12" Maximum 356 mm / 14" width can only be transported. Min. 120 x 85 mm / 4.725" x 3.347"	
Trim Width	Max. 25.4 mm / 1" Min. 2 mm / 0.08"
Trim Thickness	Max. 5 mm / 0.195"
Production Speed	Max. 4,000 booklets per hour
Voltage/Frequency	Single Phase 200 V to 240 V, 50 / 60 Hz
Machine Dimensions	W1,063 x D845 x H1,076 mm / W41.9" x D33.3" x H42.4"



Change the **focus**

\*The machine design and specifications are subject to change without any notice.

---

**Horizon**

**HORIZON INTERNATIONAL, INC.**

510 Kuze Ooyabu-cho, Minami-ku, Kyoto, 601-8206, Japan  
Phone : +81-(0)75-934-6700 Fax : +81-(0)75-934-6708  
[www.horizon.co.jp](http://www.horizon.co.jp)

Distributed by

 **STANDARD**

---

Standard Finishing Systems, 10 Connector Road, Andover, MA 01810  
877-404-4460 978-470-1920 Fax 978-470-2771  
[www.standardfinishing.com](http://www.standardfinishing.com)